



EVLA / New Mexico Array: Within and Beyond the 21-Km Radius



Steven Durand & Jonathan Romney

May 16, 2003

National Radio Astronomy Observatory,
a facility of the National Science Foundation
operated under cooperative agreement by

Associated Universities, Inc.



VLA - Socorro, New Mexico





Enough Fiber to Cross the United States from L.A. to D.C.



- 93.2 Km (57.9 mi) of 12 fiber cable
- 19.2 Km (11.9 mi) of 36 fiber cable
- 36.5 Km (22.7 mi) of 60 fiber cable
- 4.6 Km (2.8 mi) of 96 fiber cable
- Total trench length is 65 Km (40.4 mi)
- Total cable length is 153.5 Km (95.4 mi)
- Total fiber length is 4441 Km (2759.6 mi)
- Total delivered fiber cable cost - \$330K





Ditch Witch

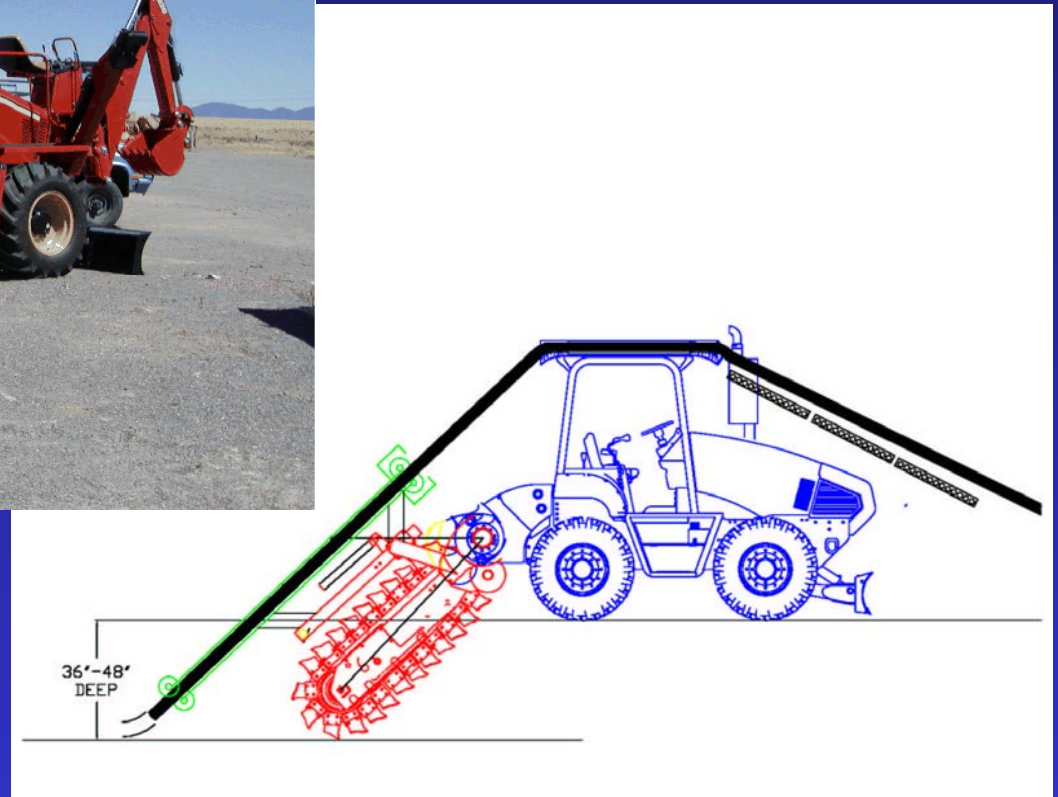



VLA West Arm Complete 22 Km of Ditch



- 6 Men 7 Months
 - \$95K Labor
- \$110K of Fiber
 - 34 locations (12 Fibers)
- Ditch Witch, Loader Grader - \$240K





Typical Termination Room

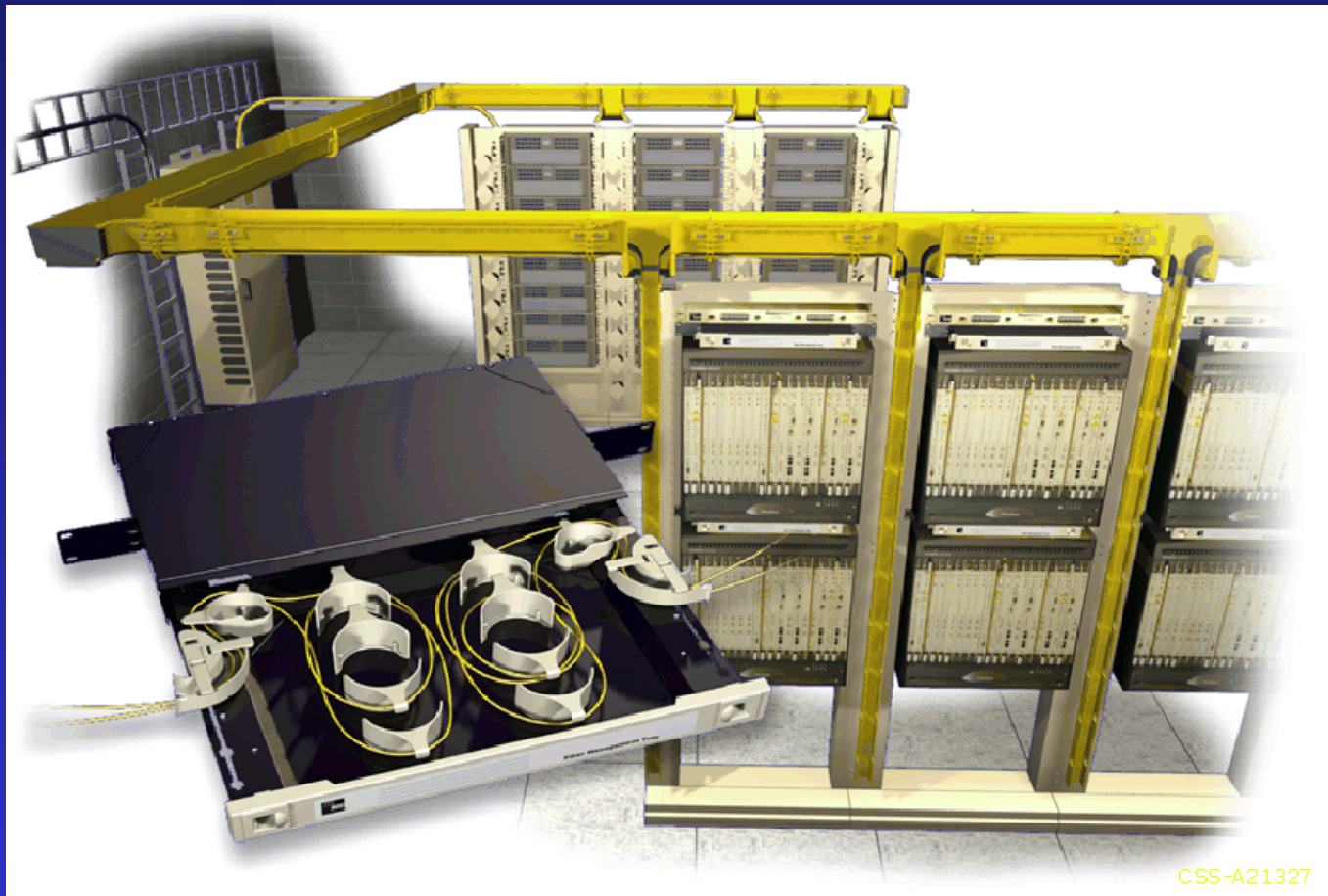

CSS-A21327



VLA Installation





New Mexico Array



- 8 New Antennas Plus VLBA
Pie Town and Los Alamos
- Range up to 250Km from VLA
- Will be implemented within the next 10 years
- Requires Time Synchronization





Commercial Hardware



- Compliant
 - GR-918-CORE
 - Phone company
- Reliable
 - Multiple Vendors
- Error Correction and Monitoring

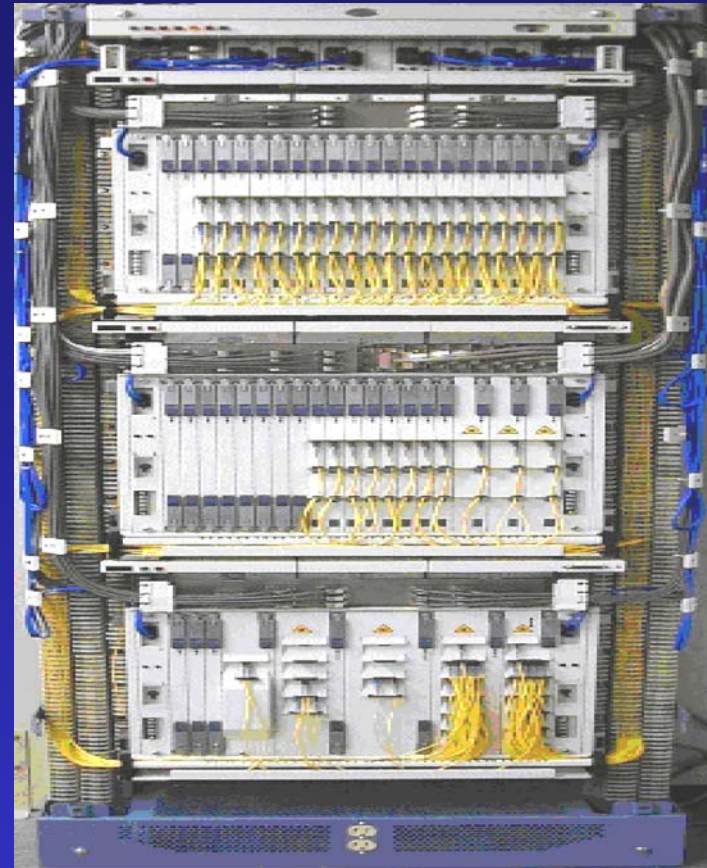



Typical Optical Reach of Different Cables vs. Format



Fiber Type	Serial GbE Distance (m)	WDM 10 GbE without Compensation	WDM 10 GbE with Compensation
Multimode	850/1300 nm	850/1300 nm	850/1300 nm
FDDI grade 62.5	220/550	26/ -	- /300
Standard 62.5um	300/550	33/ -	- /300
Premium 62.5	500/1000	33/ -	- /300
Single-Mode	1310/1550 nm	1310/1550 nm	1310/1550 nm
SMF-28	5,000/ -	10,000/40,000	40,000/100,000



COTS 15808 Solution



Control Room Site

Receiver Site

← 12 OC-192 Channels/Wavelengths
1 OC-192 Channel/Wavelength →





Data Rate

Menu	Data Rate	Description
1	9.953 Gbps	SONET OC-192/SDH SSTM-64
2	10.313 Gbps	IEEE802.3ae
3	10.709 Gbps	ITU-T G.709



Los Alamos Path

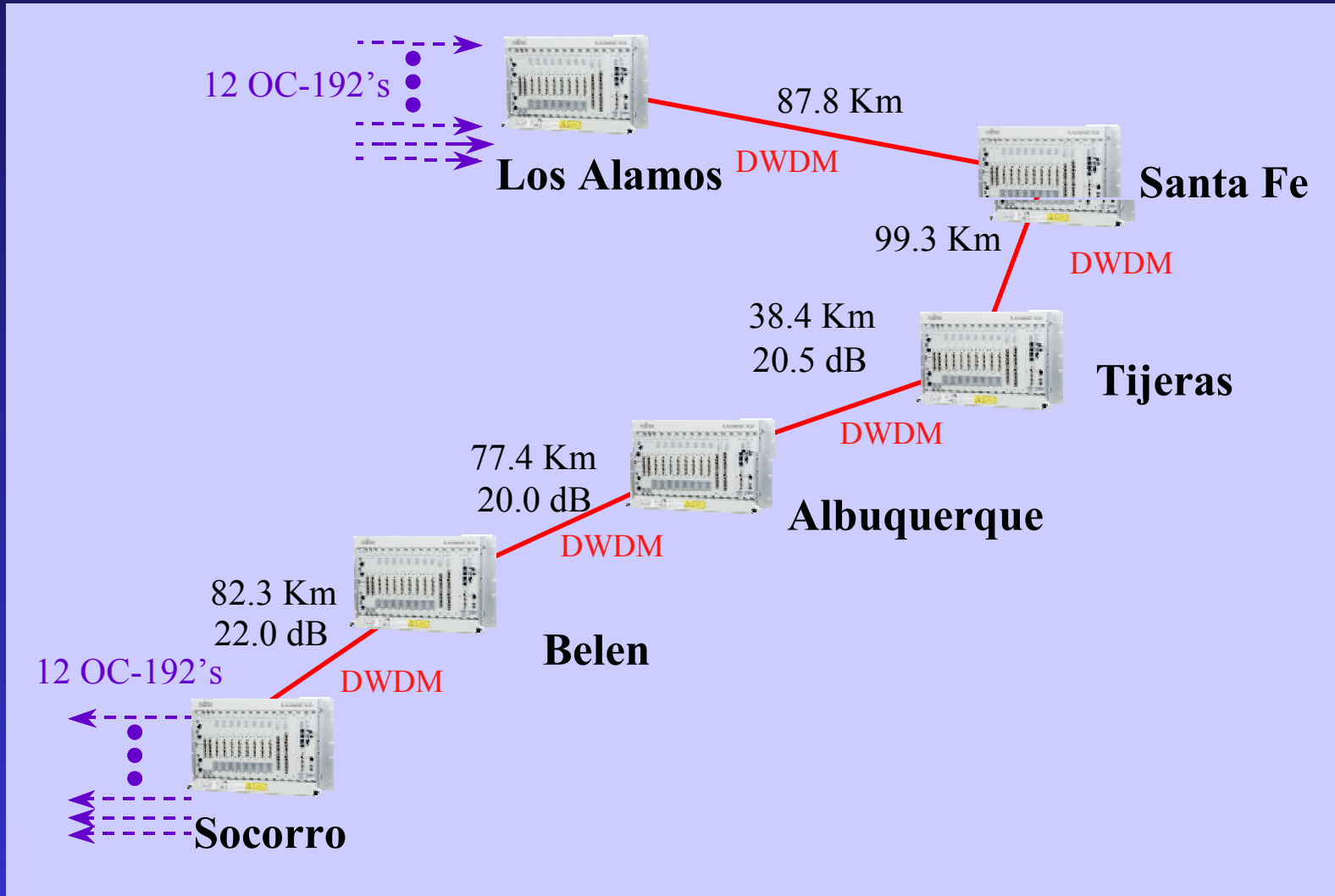



Commercial Bandwidth Provider



- First Los Alamos bid
 - 16 - OC192 links and ten years of service
 - Prepayment of \$30 Million
 - Plus \$45K per mile for fiber installation
- Fourth Los Alamos bid
 - Single direction OC192 links
 - \$0.5M per year for ten years (\$5M)
 - Plus \$35K per mile for fiber installation



Dark Fiber Solution



- Lease dark fiber from small local companies
- Obtain access to vaults and stations
- NRAO to provide all equipment including
 - Power Supplies, Air Handlers, EDFAs



NM Array Version 2

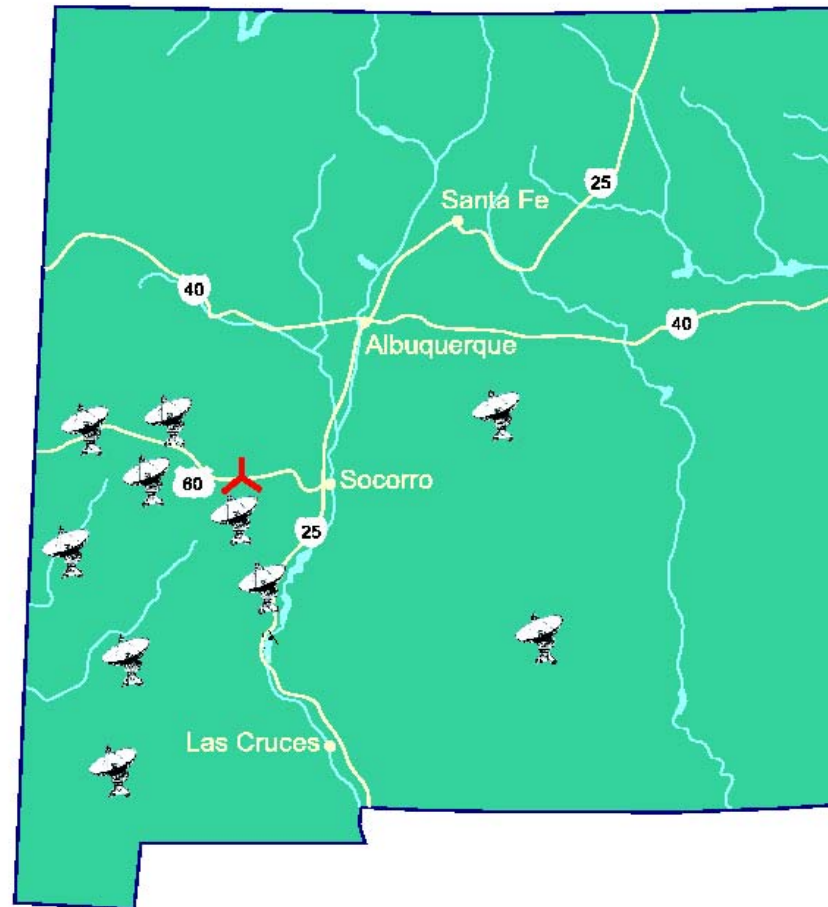



Proposed Fiber Distances

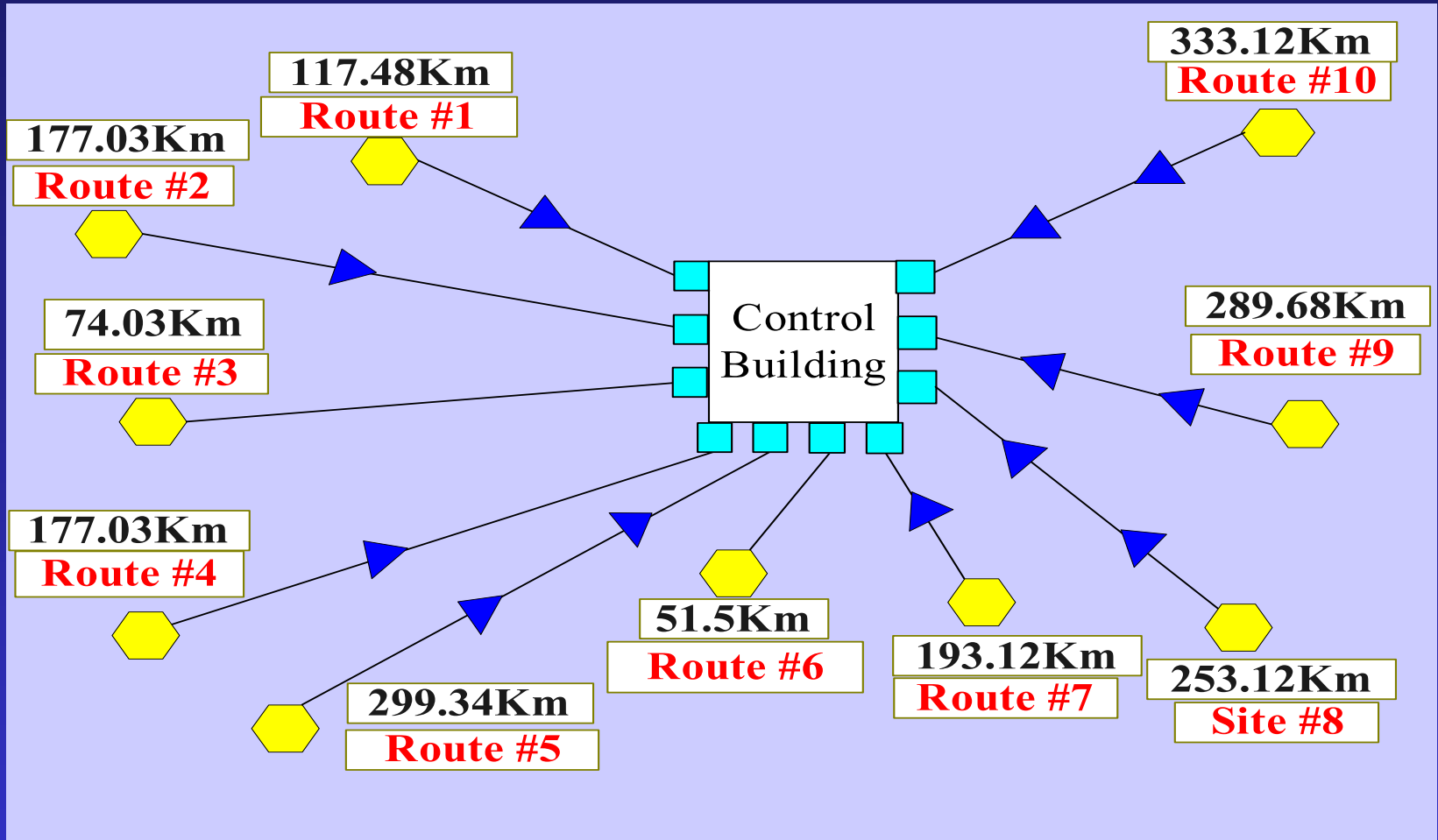



NRAO Solution



- NM Array Dark Fiber Network
 - \$698K per year for ten links (~1800 Km)
- NM Array Hardware Estimate (EVLA)
 - \$5M for ten sites including Vault Hardware
- Los Alamos Link
 - \$100K for ten years = \$1M
 - Hardware and maintenance \$0.7M
 - NRAO solution \$1.7M versus \$5M



NM Array Block Diagram

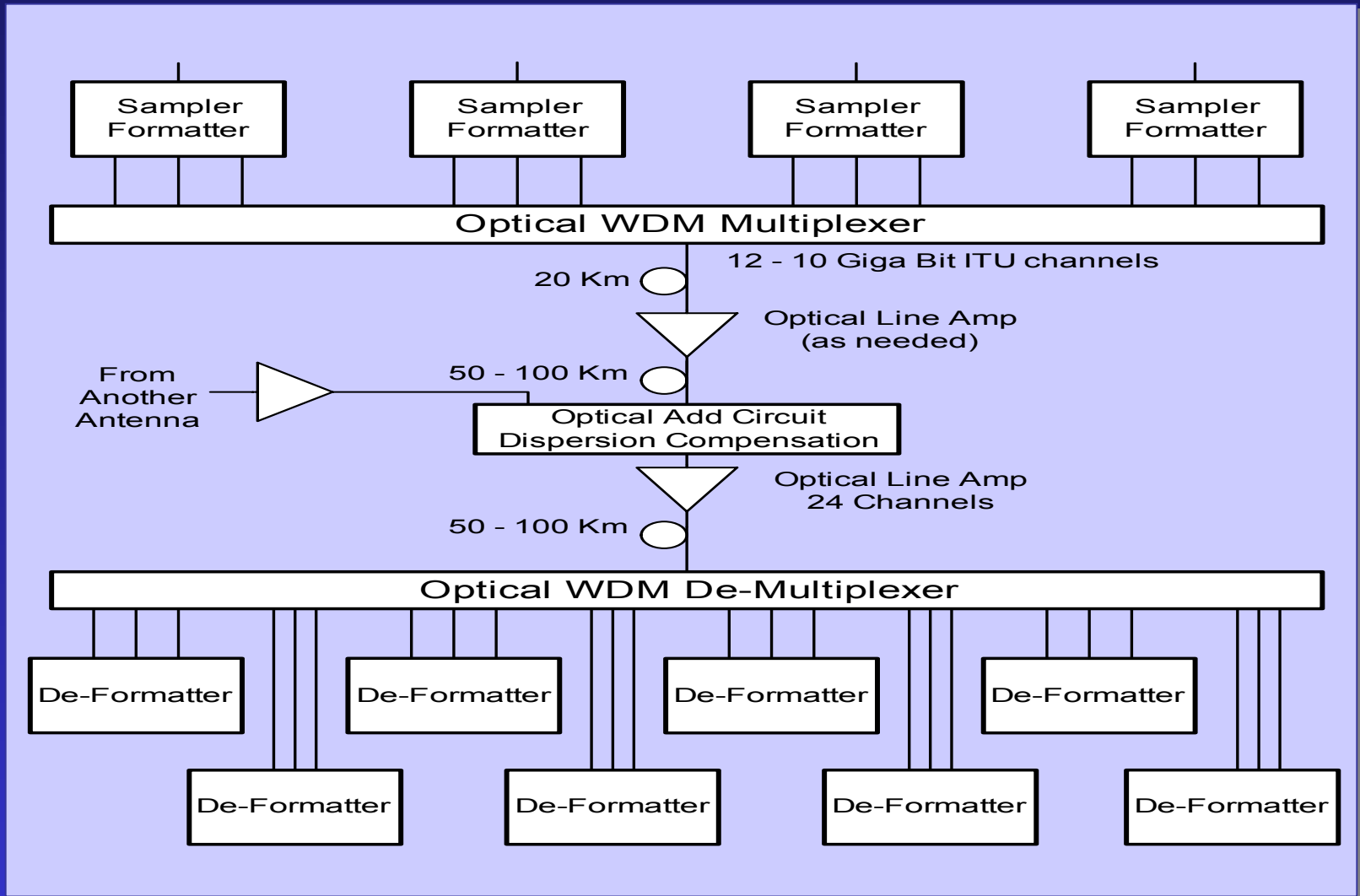



Duplex Communication

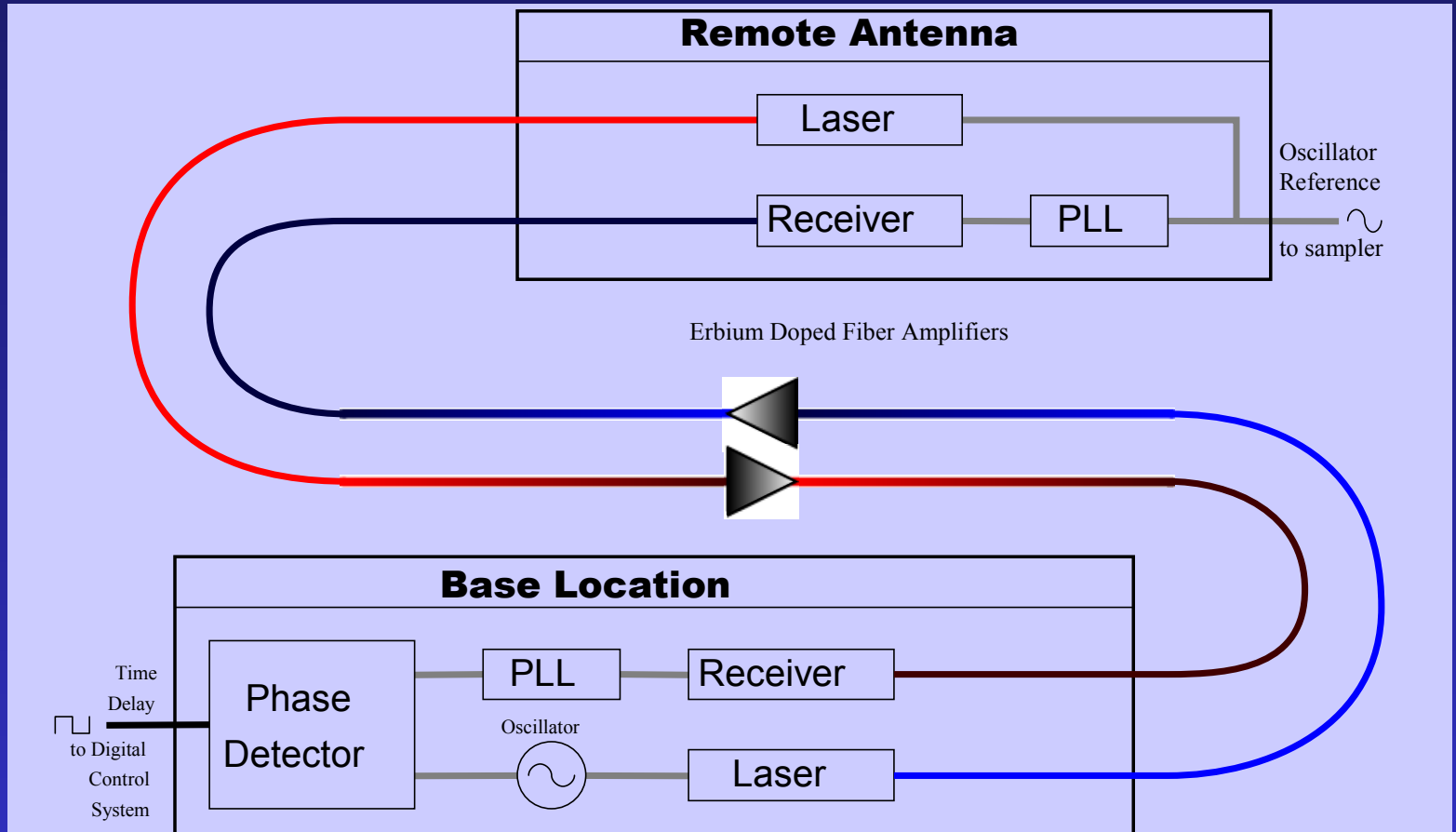



Duplex Design Overview

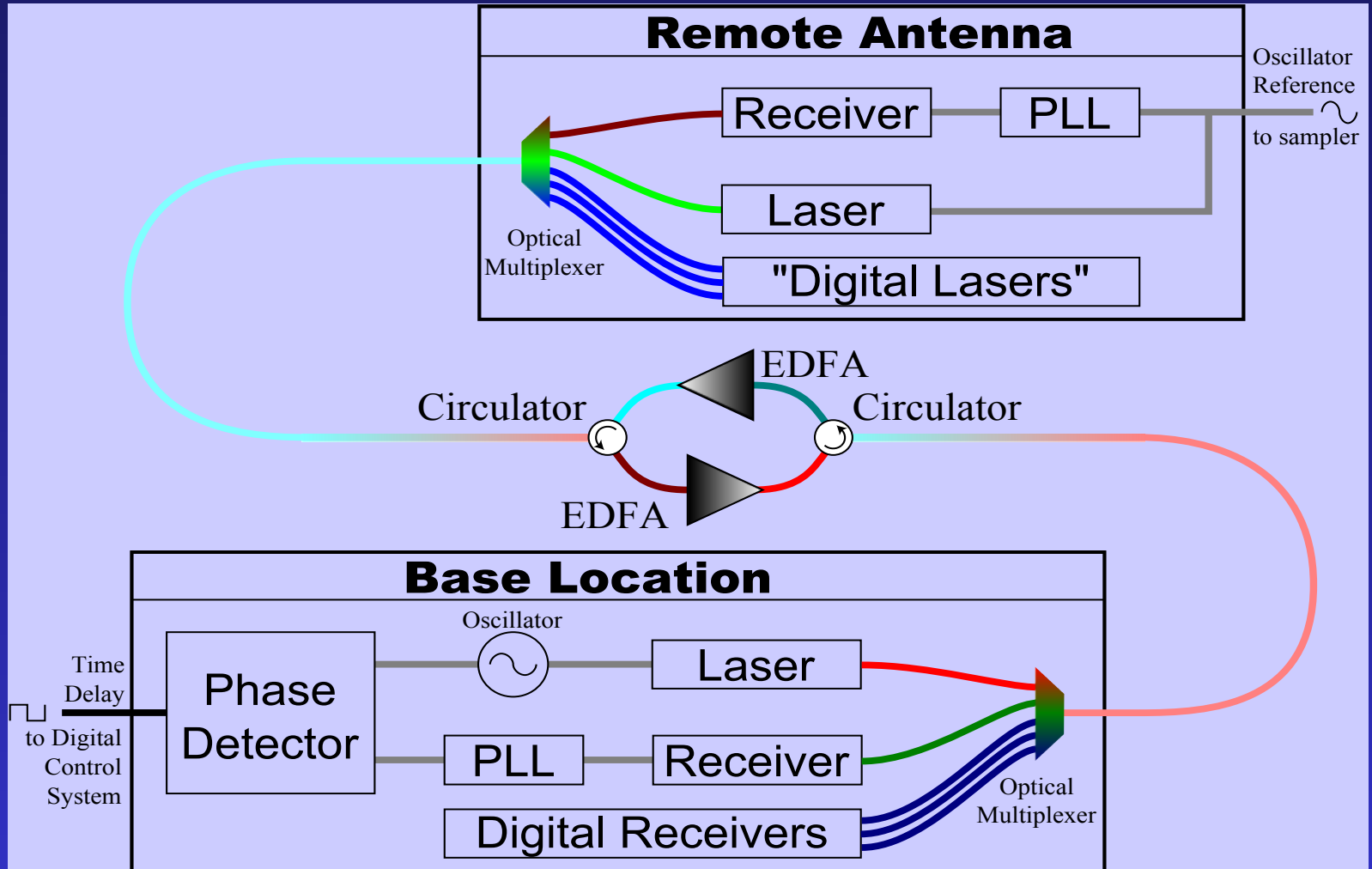



Single Fiber Results



- Full duplex Proof-of-Concept testing provided promising results:
 - 10 Gigabit Digital Signals and 512 MHz Analog
 - Acceptable isolation between channels
 - Apparent stability within 8-10 picoseconds

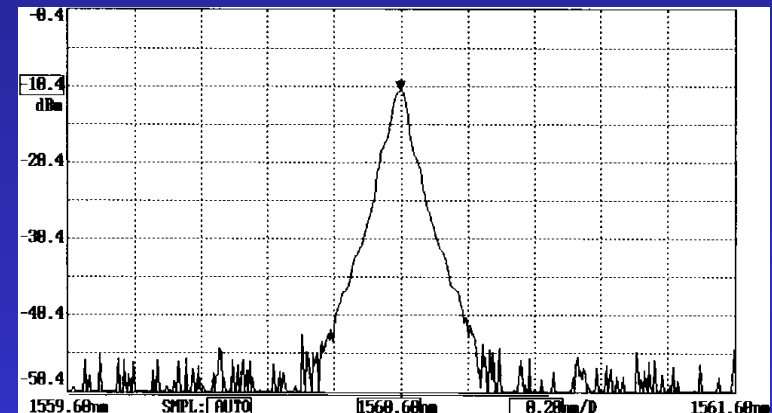
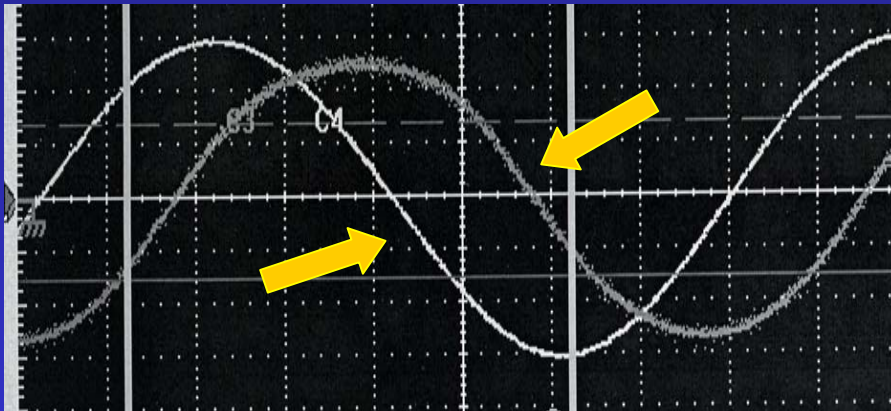



A Typical Dark Fiber Designer

